



Elvoron CPL

Vertical Platform Lift with a Full Height Cab

Technical Information

Drive System

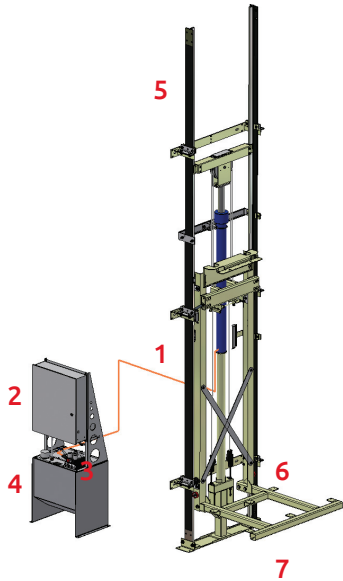

1. 1:2 Cable Hydraulic Drive
2. Computerized (PLC) controller has an emergency backup power system for lowering in the event of power failure.
3. Two-speed hydraulic control valve provides smooth, comfortable starting and stopping.
4. Submersed hydraulic pump and motor ensures quiet operation.
5. Sturdy 8 lbs per foot elevator guide rail system ensures a smooth, quiet ride.
6. Heavy duty cantilevered car support sling provides capacity of up to 1,400 lbs (635 kg).
7. Recommended pit depth is 9-1/4" (235 mm). Higher capacity and wider cars require a 12" (305mm) pit depth.

Specifications

Related Load	Standard 750 lbs (340 kg) or 1,000 lbs (455 kg). Optional 1,400 lbs (635 kg)
Speed	30 ft/min (0.15 m/s) nominal speed (USA). Optional 36 ft/min (0.18 m/s) nominal speed (Canada)
Power Supply	Elevator: Standard 208 VAC 3 phase. Optional 230 VAC single phase. Lighting: 110 VAC single phase, 15 amps
Safety Features	Emergency battery lowering. Emergency manual lowering valve. Safety brake system Automatic bi-directional floor levelling. Emergency stop and alarm button in car. Final limit switch.
Doors	Fire rated swing doors that are fitted with electro-mechanical interlocks. The doors also include a vision panel and UL listed 2-speed closer with adjustable back-check cushioning (meets ADA requirements).
Travel Range	CSA B355: 23 ft (7.0 meters), A18.1: 14ft (4.2 meters)
Code Compliance	ASME A18.1, CSA B355
Popular Options	Automatic door operators. Integrated hands free telephone. Custom car finishes. Additional handrails. Buffer springs (increases your pit depth)
Warranty	2 year standard warranty. Optional additional 5 year extended warranty (7 years)

Wall Finishes

Laminate



Designer White



Dove Grey



Cloud Nebula



Kensington Maple



New Age Oak

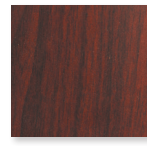

Empire Mahogany

Melamine

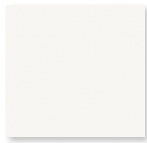

White

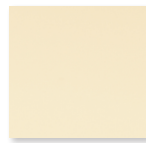

Antique White

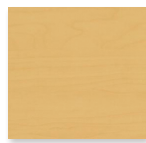

Light Maple

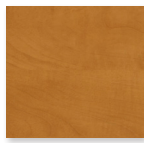

Dark Maple



Gray



Oak

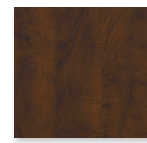

Walnut

Dimensions

Configurations

Hoistway Length

Hoistway Width



Hoistway Dimensions

	Style 1L & 1R		Style 2		Style 3 & 4		Style 5	
	mm	in	mm	in	mm	in	mm	in
36x60 Cab (914x1524mm)								
Hoistway Width	1365	53 ³ / ₄	1365	53 ³ / ₄	1381	54 ³ / ₈	1381	54 ³ / ₈
Hoistway Length	1616	63 ⁵ / ₈	1556	61 ¹ / ₄	1680	66 ¹ / ₈	1683	66 ¹ / ₄
42x60 Cab (1066x1524mm)								
Hoistway Width	1518	59 ³ / ₄	1518	59 ³ / ₄	1534	60 ³ / ₈	1534	60 ³ / ₈
Hoistway Length	1718	67 ⁵ / ₈	1759	69 ¹ / ₄	1781	70 ¹ / ₈	1683	66 ¹ / ₄
48 x 60 Cab (1220x1524mm)								
Hoistway Width	1670	65 ³ / ₄	1670	65 ³ / ₄	1686	66 ³ / ₈	1686	66 ³ / ₈
Hoistway Length	1718	67 ⁵ / ₈	1759	69 ¹ / ₄	1781	70 ¹ / ₈	1683	66 ¹ / ₄



Garaventa Lift

18920 36th Avenue · Surrey, BC · V3Z 0P6 · Canada

T 800 663 6556 (toll free North America)

E info@garaventlift.com · I www.garaventlift.com

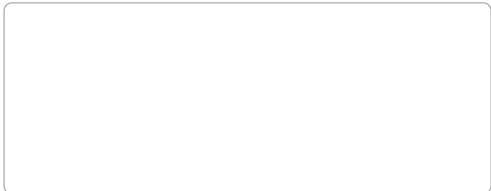

Authorized Garaventa Lift Representative

© Garaventa Lift. As we are continuously improving our products, specifications outlined in this brochure are subject to change without notice.



37158-U-PB-EN